

# Karelia

HARDWOOD FLOORS



## INSTALLATION GUIDE

---

KARELIA FLOATING WOOD FLOORING WITH PROFILOK 5G

Karelia-Upofloor Oy  
Sinimäentie 8A  
FI-02630 Espoo, Finland  
Phone +358 (0)20 740 9300  
[www.kareliafloors.com](http://www.kareliafloors.com)

# CONTENT

## **INSTALLATION REQUIREMENTS FOR WOOD FLOORS PAGE 3**

- General
- General preparations
- Installation instruction Profiloc 5G

## **INSTALLING KARELIA WOOD FLOORS OVER UNDERFLOOR HEATING PAGE 5**

- Installation

## **WHAT TO CONSIDER BEFORE INSTALLATION PAGE 6**

- Scheduling installation
- Storage
- Installing boards in patterns
- Fixtures and fittings
- Planning floor installation
- Movement joints in wood floors
- Uneven subfloors
- Choice of laying direction, max. widths
- Calculate the skirting board thickness
- Cleaning the subfloor

## **WHAT TO CONSIDER WHEN INSTALLING PAGE 8**

- Temperature and humidity conditions
- Opening packs
- Inspection
- End joints in small areas
- Gluing joints
- Pattern misalignments
- Door openings
- Fitting skirting boards
- Bowing

## **WHAT TO CONSIDER AFTER INSTALLATION PAGE 9**

- Protective covering
- Tape
- Ventilation
- Colour changes

## **INSTALLATION AND FITTING INSTRUCTIONS PAGE 10**

- Installation instructions for Karelia wood floors with Profiloc 5G joints
- Installation instructions for Karelia on 150 kPa expanded foam (domestic)
- Installation instructions for Karelia wood floor on 250 kPa expanded foam (public)

## **KARELIA POLICY ON FLAWS AND REJECTION OF MATERIAL DURING INSTALLATION PAGE 13**

## INSTALLATION REQUIREMENTS FOR FLOATING WOOD FLOORS

---

### General

Wood is hygroscopic, ie, it is a “living” material. Depending on the ambient air humidity and temperature, the material either emits or absorbs moisture. This is associated with a change of volume (swelling or shrinkage). It is therefore important that there is an “expansion gap” or “movement joint” in between the floor and the wall and other fixed objects when a wood floor is installed floating. To stop the floor absorbing moisture prior to installation, it is important not to open packaging until just before installation.

Many mistakes and damage to the floor can be avoided by studying the installation instructions before starting installation and then following them carefully.

Note that moisture levels in new build premises often remain relatively high by the time wood floors are installed.

To avoid damage, it is important that the relative humidity during and after installation is less than 60%. The temperature of rooms and materials must be at least 15°C. A wood floor must not therefore be installed until all other trades, such as painters and tilers, have finished their work and the site has the correct RH.

Moisture protection is not normally necessary on structural floors where the relative humidity is below 60%. Note that newly cast structural floors do not meet this requirement, so a moisture barrier is always needed.

A moisture barrier on the following subfloors, whatever their age, is obligatory for the reasons given below:

- concrete floor lying directly on the ground (ground-supported slab)
- floor above warm or humid area (e.g. boiler room or laundry room)
- structural floor above a ventilated crawl space foundation
- lightweight concrete floor structures
- underfloor heating

If the subfloor’s relative humidity is higher than 90%, a plastic sheeting vapour barrier will not provide a sufficient moisture barrier.

Wood floors should always be laid staggered in every row, even in small areas such as hallways. Distributing the short ends evenly means that the floor will remain flat and level even during seasonal climate changes.

Karelia products and installation methods follow the guidelines set out in AMA Hus. (in accordance with the Swedish Building Regulation System - AMA Hus.)



### General preparations

- Store the floorboards in their packaging. *Figure 1.*
- Open the packs only when needed during installation.
- Read the installation instructions carefully before installing.
- The subfloor must be dry, level, clean and solid. *Figure 2.* Remove fitted carpets.
- Check that the subfloor is flat and level over measured lengths of 2 m and 0.25 m. If any unevenness exceeds 3 mm over 2 m or 1.2 mm over 0.25 m, the floor must be levelled first. Karelia also accepts a measured length of 1 m. The tolerance in this case is 2 mm. *Figure 3.*
- Check the humidity of the subfloor. Subfloors consisting of newly cast concrete joists or lightweight concrete joists, ground-supported concrete floors, above warm or humid areas, over crawl space foundations or over an underfloor heating system must first have age-resistant 0.2 mm polyethene (PE) sheeting laid to protect against moisture. Lay the sheeting with a min. overlap of 200 mm. The subfloor must be cleaned thoroughly to prevent mould. If the subfloor's relative humidity is higher than 90%, a plastic sheeting vapour barrier will not provide a sufficient moisture barrier. Before starting to install the floor, any moisture problems should be taken care of.
- The room's relative humidity shall be between 30–60% RH. The temperature of the room and the boards must reach at least 15°C. *Figure 1.*
- Where applicable, an intermediate layer can be laid on top of the sheeting to reduce impact noise. Use 2–3 mm polyethene foam in combination with the sheeting or use Karelia Tuplex. Butt joint the edges of the intermediate layer. If an impact sound reduction is required, please contact an acoustics specialist.

- In narrow rooms, lay the boards in the long direction. The floor moves as the air humidity varies, and should therefore have a movement joint. For practical purposes, for floors < 6 m wide allowing a 10 mm movement joint next to walls and fixed objects (stairs, pillars, door frames, etc.) is convenient. For larger floor areas (> 6 m wide) allow 1.5 mm of movement joint per metre of floor width. This movement joint must run all round the floor. For 14 mm multi-layer flooring with Profiloc SG the maximum floor width is 15 m and the maximum length 25 m.
- Put damaged or faulty boards to one side. They may be surplus or useful for finishing off. You can, of course, exchange any damaged boards where you purchased them.

If you make a mistake, boards with Profiloc SG can be taken up and re-laid quickly and easily, which simplifies the procedure. The Profiloc SG joint helps reduce errors during installation.

We recommend that you consult your floor supplier or ourselves regarding building moisture if you want to lay the floor on a construction other than those described in our brochure *Subfloor Requirements and Underfloor Heating*, if you want to lay a large floor or if anything else is unclear.

## INSTALLING KARELIA WOOD FLOORS OVER UNDERFLOOR HEATING

---

Make sure that all the necessary tests on the underfloor heating system have been completed before the flooring installation begins.

### Installation

The working temperature (materials, subfloor and room air) during installation must be at least 15°C. As with installation where there is no underfloor heating, the relative humidity (RH) of the air must be between 30–60% before, during and after installation.

Note that a cold subfloor warms up slower than the room air.

Note that the requirement for movement joints at door openings is greater with underfloor heating because the floor moves more. Remember that a floor installed over underfloor heating is more vulnerable to moisture (high RH) than an unheated floor, because the floor's moisture content varies over a wider range.

A vapour barrier of an approved type is compulsory.



## WHAT TO CONSIDER BEFORE INSTALLATION

### Scheduling installation

Wood floors must not be laid until all other work, e.g. painting, wallpapering and tiling, is completed. The site must have the correct RH. This avoids contamination and moisture damage to the floor.

Installing floors is easier if architraves, etc., are fitted afterwards.

### Storage

Wood flooring must be stored in an area where the RH is less than 60%. Do not open the packs of flooring until you are ready to install. Open the packs only when needed during installation.

Before installing a wood floor, ensure that the material has a minimum temperature of 15°C. It takes approximately two to three days storage in a heated location before the bundles reach the correct temperature. The temperature can be reached quicker if the floor packs are stacked in several small piles rather than a single pile. If the protective plastic has been damaged, repair it with tape to prevent moisture damaging the contents.

### Installing boards in patterns

We recommend gluing to the substrate when the boards are to be laid in different directions in the same room. Floors with Profiloc SG joints cannot be installed with short ends against long sides.

### Fixtures and fittings

Fixtures and fittings, kitchen island units, partitions, etc., must never be fixed to the parquet in a floating installation. They can be fixed through the floor provided a space is allowed, to prevent the fixed object from pressing down on and trapping the parquet. There must be a movement joint around the space.

Fix all the fixtures and fittings first, and then the floor. If the wood floor needs to be installed under the fixture or fitting for any reason, there must be a movement joint under the kickboard.

Modern kitchen units are normally fixed to the wall, with supporting legs at the front resting on the floor. This is generally of no significance to the floor. However, if the worktop is made of marble, granite or another heavy material, the legs should not rest on the floor to avoid trapping it.

If a wood-burning stove or similar is to stand on the floor, lay (e.g.) chipboard over an area slightly smaller than that of the "spark screen". This not only enables the floor to move freely but also makes it easier to replace boards near the stove if necessary. The chipboard also takes the weight of the stove. Remember to provide an expansion gap.

### Planning floor installation

Measure the width of the room, and calculate the width of the last row of boards. If it is less 30 mm, you should also cut the first row of boards, to equalise the widths of the first and last rows. Remember to include an expansion gap.

When installing floors with Profiloc SG joints, it is easier if you start on the longest side of the room with most doors. If there are doors along the short side of the room, begin each row of boards there. The boards can be installed from both left and right, as well as "backwards". If the area is geometrically complex, think carefully about the best method of installation, where you should begin laying and suitable places for expansion joints. Plan carefully to avoid exceeding the maximum width of 15 m for 14 mm multi-layer flooring with Profiloc SG and to ensure adequate skirting board dimensions.

### Movement joints in wood floors

Natural seasonal variations cause a certain amount of movement (expansion and contraction) in wood floors.

This is why a floor must not be laid too close to adjacent walls or other fixed objects. A movement joint must be provided along each edge.

The floor must be able to expand at thresholds, door frames, heating pipes, pillars, stairs, tiled floors, other parquet flooring, etc. It is important to ensure that contraction caused by climate variations in winter will also be covered by the skirting board.

Gaps caused by contraction do not normally occur in floors with Profiloc SG joints, which is why all contraction manifests itself at the outer edges.

An expansion joint (movement joint) between two rooms/floor areas can be concealed with a threshold.

**Remember that the width of the expansion joint is the sum of the widths of the movement joints for each connecting area.**

When wood floors are delivered their moisture content corresponds to approximately 40% RH.

The floor's RH normally varies seasonally between 30% and 60%. A wood floor must be able to move with the variation in moisture, which produces both expansion and contraction.

**The size of the movement joint in mm is calculated using the formula: 1.5 mm x metre floor width. The size of the movement joint should never be less than 10 mm.**

A 8 m wide room should therefore have an expansion gap around the edge of  $8 \times 1.5 \text{ mm} = 12 \text{ mm}$  between the floor and all fixed objects.

Graph shows: A wood floor's movements as it absorbs and emits moisture.

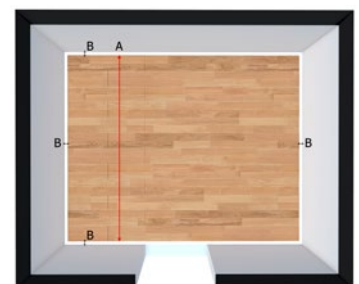
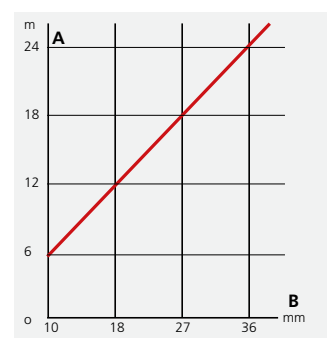

Note that the dimensions of the skirting board must never determine the size of movement joints. With large floor areas, the skirting board must therefore be selected on the basis of the required size for the expansion joint and not vice versa.

One solution for a situation that requires a large skirting board: In new buildings, a simple way of permitting additional floor movement is to “stop” wall panels immediately above the floor surface. If the wall panel is 13 mm plasterboard, for example, this provides an additional 13 mm movement allowance. This allows a thinner skirting board to be used than would otherwise be necessary.

Karelia Accessories range includes installation wedges that are easy to use and ensure a sufficient and accurate expansion gap.

Make sure that the floor does not go under the wall panel, e.g. plasterboard.

**Calculate the skirting board thickness**

Make sure that the floor does not end up under the sheet!

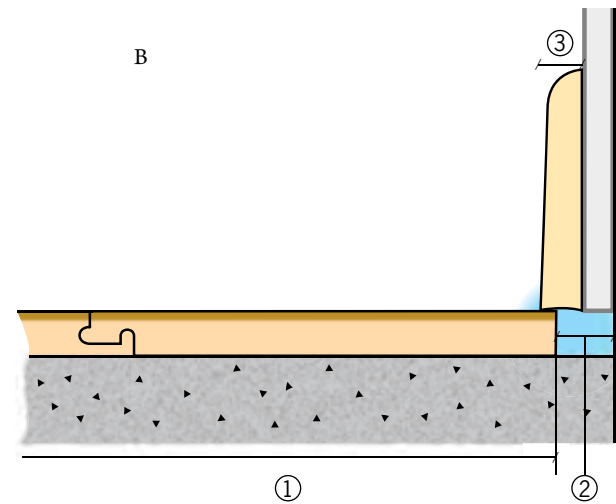
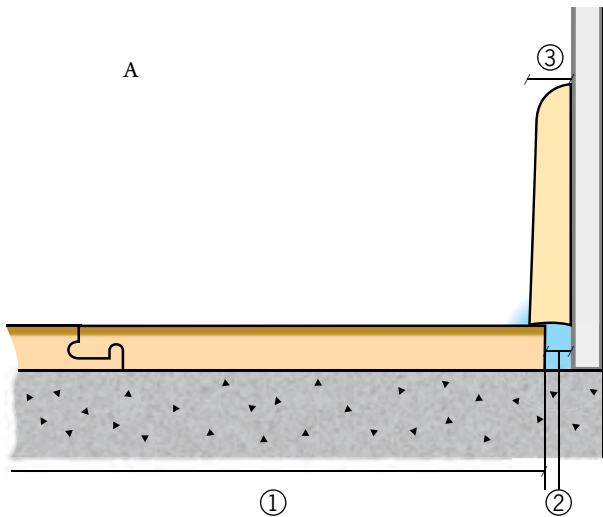

- 1. Floor width x 1.5 = expansion gap in mm.
- 2. Movement joint

- 3. Movement joint x 1.5 = skirting board minimum thickness in mm

**MINIMUM SKIRTING BOARD THICKNESS FOR VARIOUS FLOOR WIDTHS**

Floor width 1	Movement joint 2	Cover allowance	Skirting thickness 3
4 m	6 mm	3 mm	15 mm*
6 m	9 mm	5 mm	15 mm*
8 m	12 mm	6 mm	18 mm
10 m	15 mm	7 mm	22 mm
12 m	18 mm	9 mm	27 mm
15 m	22 mm	11 mm	33 mm

\* Because a minimum 10 mm movement joint is demanded.

**Uneven subfloors**

If small depressions in the subfloor are noticed during floating installation, they can be filled using felt paper (max. 3 layers with underfloor heating). However, do not use more than one layer of Cellofloor or similar because it is excessively soft.

**Choice of laying direction, max. widths**

We recommend laying lengthways because boards move less along their length than across their width. In narrow areas, such as halls, it is particularly important that the boards lie flat against the subfloor and must be installed lengthways.

Laying diagonally is more time-consuming but can be very eye-catching.

Remember that the maximum width (at right angles to the boards) must not be exceeded (15 m). If the floor is wider than this, it must be divided (expansion joint). Take into account that the wastage will be a little higher (8–10%). Particular consideration must be given if the room does not have a simple geometric shape.

**Cleaning the subfloor**

Never leave sawdust or other organic residues on the subfloor. There is a high risk of mould if the space between the vapour barrier and the subfloor contains organic material and high humidity.

## WHAT TO CONSIDER WHEN INSTALLING

### Temperature and humidity conditions

The working temperature when laying should be at least 15°C. This applies both to the boards and to the room air. The relative humidity of the air must be between 30–60% before, during and after installation.

### Opening packs

The wood floor is supplied “furniture dry”. If packs are opened too early, the boards can absorb moisture and expand, which makes them difficult to fit together. If packs have been opened, they must be resealed carefully with tape to stop moisture getting in and adversely affecting the boards.

### Inspection

It is always easier to rectify faults if they are discovered early. Always make a habit of inspecting the product at the time of installation. Faulty products can of course be exchanged with your supplier or ourselves. Boards with obvious faults that are detectable before installation must not be used. Always make sure that inspection and installation are carried out in good light. *Figure 1.*

### End joints in small areas

Even small areas must be laid staggered, i.e. all floor areas must have end joints in every row. The end joints of adjoining rows must be staggered by at least 500 mm to ensure that the floor remains flat and level during climatic variations, otherwise there is a risk that the floor could bow in high relative humidity. *Figure 2.*

### Gluing joints

Adhesive should not normally be used on boards with Profiloc 5G joints. However, installation is sometimes easier if 1/3 of the locking edge is planed off and adhesive is applied to the horizontal underlip (see illustration). This means the board can be tapped into place. The joint will be sufficiently strong because of the wide area of adhesive. *Figure 3.*

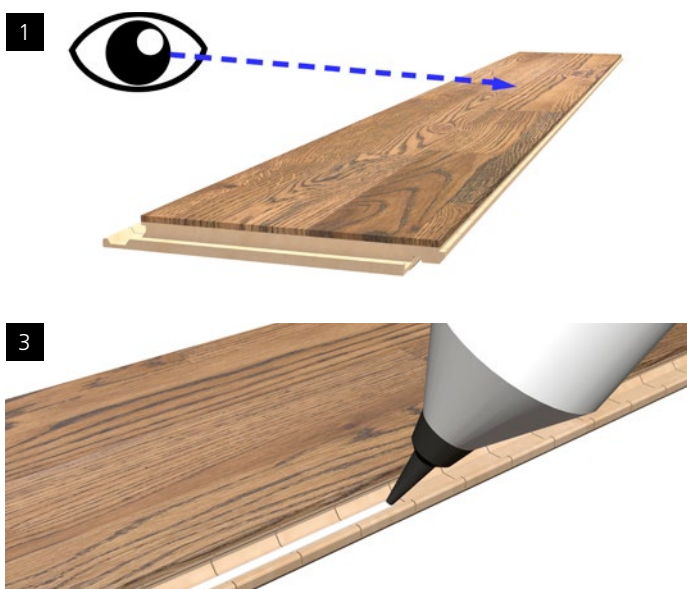

### Pattern misalignments

Minor pattern misalignments that occur during manufacturing are permitted in accordance with HusAMA (the Swedish Building Regulation System – AMA Hus. Pattern misalignment may occur with some floors such as those from the Dutch pattern floors. When laying boards with a Dutch pattern, the transverse strip must fit in the centre of the longitudinal strip on the adjoining row of boards.

### Door openings

Floors installed through door openings or archways must be divided with an expansion gap which is then covered by a threshold or moulding. If an existing threshold is fixed to the subfloor, there must be a movement joint, of the same dimension as the other movement joints in the room, between the wood floor and the threshold. Note that there is a greater requirement for an expansion joint in door openings where underfloor heating is fitted. The threshold can also be removed, then refitted, when the floor has been laid with a joint under the threshold's position. If the threshold is too high, the door can be trimmed accordingly. Cutting the door is easier if you mark the cut line with tape and use a fine-toothed saw. *Figure 4.*

### Fitting skirting boards

The skirting boards must not press down on the wood floor, as they may trap it. Skirting boards can be fixed to walls using nails, screws or adhesive. Best results are achieved if the joints are mitred. Skirting boards must be adapted to suit the size of the movement joint.

### Bowing

We aim to manufacture boards that are slightly convex lengthwise to make the floor easy to lay. Do not forget to stagger the end joints in accordance with the installation instructions.

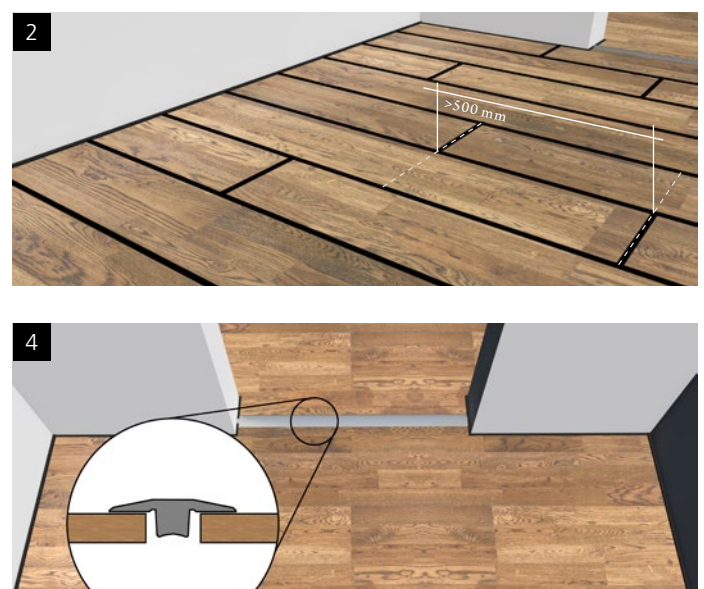



## WHAT TO CONSIDER AFTER INSTALLATION

---

Spilt liquids must be wiped up immediately. This is particularly important for Beech and Hard Maple, because they move more than other species because of their greater sensitivity to moisture.

For more detailed information about care and maintenance, refer to our *Maintenance Guide brochure*, which can be downloaded at [www.karelia.com](http://www.karelia.com).

### **Protective covering**

If further work is to be carried out in the room where the floor has been installed, the floor must be protected with a moisture permeable material (e.g. paper). Check that this will not discolour the floor. Note that some commonly used types of papers do not allow moisture to pass through, and have a wax coating that may be transferred to the wood floor. This causes undesirable gloss variations.

White goods do not usually have sufficiently large “wheels” to avoid causing damage if they are moved across the floor, in which case the floor requires much greater protection than protective paper alone.

### **Tape**

Tape only to the protective covering, not to the wood floor. Many types of tapes stick to the floor so firmly that they lift the lacquer when removed. The longer the tape is left in place, the greater the risk of it adhering too strongly to the lacquer.

Karelia have selected tape which will prevent damages to the floorboard. Please contact your customer support for details.

### **Ventilation**

When a floor is installed in a new building, ensure adequate ventilation to prevent building moisture damaging the floor. If the RH is higher than 60% there can be permanent deformation due, for example, to cellular collapse and/or laminate penetration.

### **Colour changes**

Wood is a natural material that gradually matures to its natural colour, this happens most quickly to start with. To achieve an even surface, carpets should not be laid on the floor during the first few months after installation. If there are already light patches from carpets etc, they quickly mature when exposed to daylight.

More information on color changes for your specific product is available on our Technical data sheet, please contact customer support for more information.

## INSTALLATION INSTRUCTIONS FOR KARELIA WOOD FLOORS WITH PROFILOC 5G JOINTS

### Preparation

- If the installation requires a vapour barrier, do not forget it.
- First, calculate how many floor boards are required. If the last row is less than 30 mm wide, cut the first row, too. When installing floors with Profiloc joints, it is easier if you start on the side with most doors. If there are doors along the short side of the room, begin each row of boards here. The boards can be installed from both left and right.
- The maximum width is 15 m for Karelia wood floors with Profiloc 5G joints. If the floor is wider, contact Karelia.

**1.** Begin in one corner, and work from left to right with the long underlip facing into the room. The gap between the long side and the wall can be adjusted once three rows have been laid. Start in a corner and lay the groove sides – the long under-lip – outwards into the rooms. Insert a wedge on the short side of the board. The distance from the long side to the wall can be adjusted later when three rows have been laid.

**2.** Angle the floorboards as shown in figure 2. Continue in the same way for the whole of the first row.

**3.** Cut the last board in the first row to the right length and start the next row with the piece left over. The board's end joints should be displaced by at least 500 mm during installation.

**4–5.** When assembling the floorboards the angle is important and should be approximately 20°. A maximum angle of 30° is recommended. When assembling the boards you start by positioning the board into the groove of the previous row.

**6–7.** Position the board using the correct angle (20–30°). Adjust the board into a position where the two short edges touch at the corner in accordance with the illustration. Make sure that the joint is free from dust or other particles.

**8–11.** Fold down the board into a position aligned with the surface of the previous board. This can be facilitated using a Handblock. Positioning the boards requires only light taps on their edges. Hold the tapping block lengthways against the edge of the board. Keeping one end in contact with the edge of the board, tap the board with the block. This applies the correct force, and the board will not be damaged.

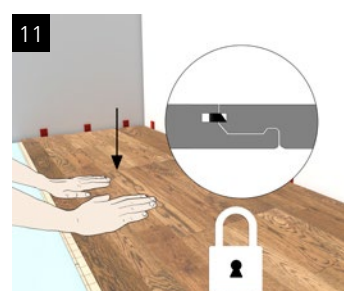
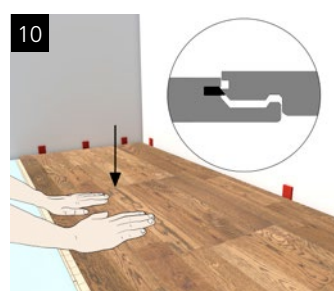
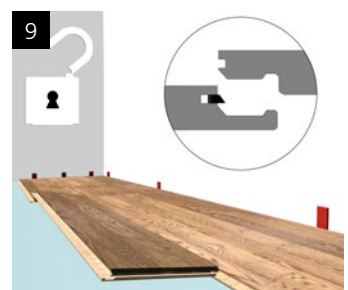
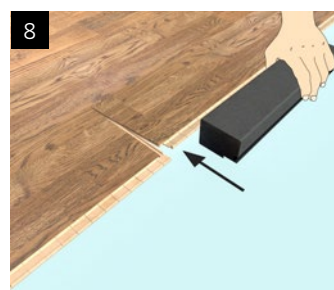
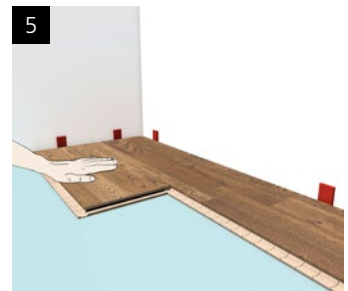
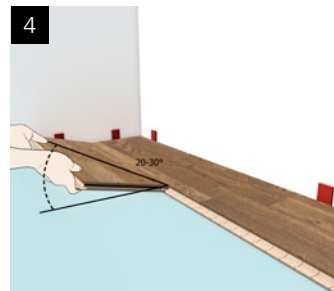
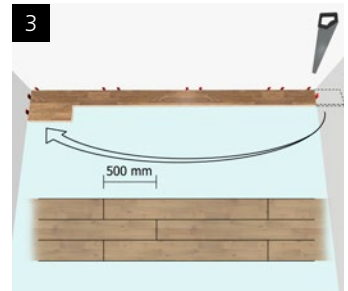
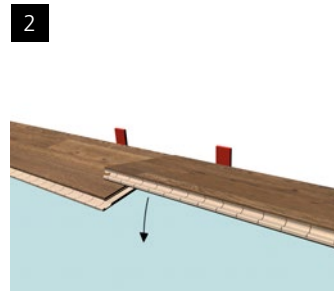
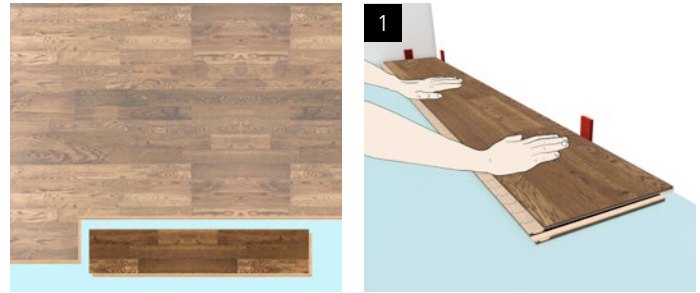

**12.** When three rows have been laid, the distance from the floor to the walls can be adjusted. Place wedges between the floor and wall.

**13.** The final board is then sawn to the correct width. Lay the final board on top of the penultimate board row with an approximate 5 mm displacement to the wall. Mark the section to be sawn using a piece of board with a locking strip. Lay it against the sawn board. Do the same with the next piece.

**Dismantling**

A, B, C. The installed boards can be dismantled. Fold up a whole row and slide the row aside. Unlock the short end joint by sliding the boards horizontally along the short edge joint.

**A few problems that are easy to solve.**

**D.** Drill holes in the board to accommodate heating pipes. The holes must be at least 20 mm larger than the pipe's diameter. Make saw cuts as shown in the diagram. When the board is fitted, the sawn piece needs to be glued in place and the holes covered with pipe collars.

**E.** If you have to cut a door architrave, use a floorboard as a base so you get exactly the right height. If you need to knock a board along its length, protect the board's joint with a cut piece from a short end inserted into the joint.

**F.** Always begin each row of boards from a doorway. This makes it easier to push the prepared board under the frame. With Profiloc 5G, the other boards in the row can be laid from either left or right.

**G.** When laying the board's short end against a door frame, the board needs to be adapted to the frame or the door architrave needs to be cut. Lay the board as close to the door frame as possible and then knock it in carefully from the short end. Protect the board using a cut piece (e.g. a suitable short end).

**H.** If you are unable to angle the board in at a door architrave, plane off 2/3 of the locking moulding. This allows you to tap the board into place. Apply adhesive to the underlip to avoid weakening the joint.

**I.** When installing under reveals it is often easiest to fit these boards before the return wall board is laid.

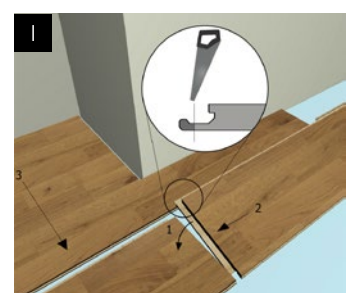
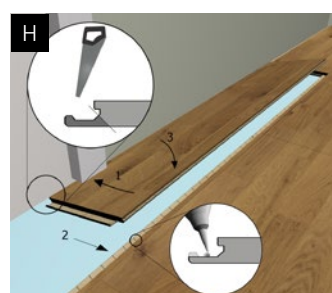
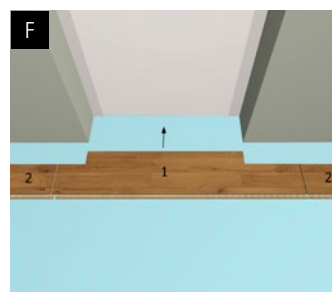
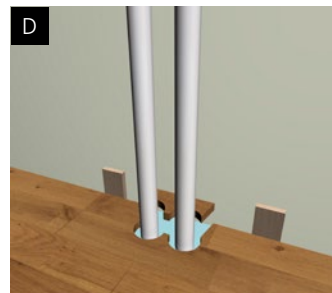
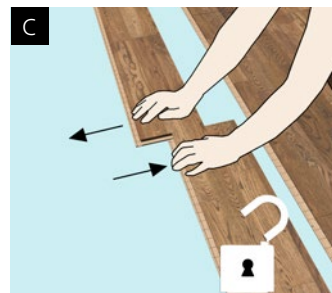
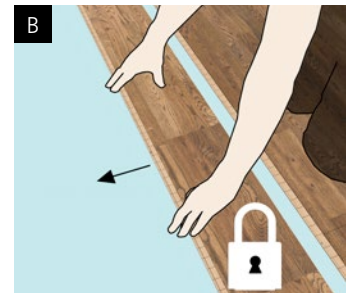
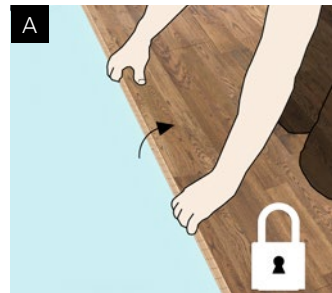
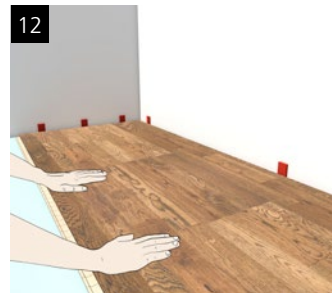

## INSTALLATION INSTRUCTIONS FOR KARELIA ON 150 KPA EXPANDED FOAM, FLOATING, IN DOMESTIC ROOMS INSULATED WITH EPS

---

The foam sheets must comply with min. Group M, compression strength =150 kPa (density 30 kg/m<sup>3</sup>). It is important that they are designed for this application and that they comply with the requirements for thickness tolerance and density. The density must be within ±10%.

To avoid undesirable flexing of the finished floor, the thickness tolerance of the sheets must be ±0.5 mm. For the same reason, bowed sheets must not be used.

Lay the foam sheets at right angles to the direction that the floor will be laid and stagger them so that there are no continuous joints running lengthways along the boards. The entire subfloor must be covered with

foam sheets in such a way that the boards are supported. Special attention must be given to pipe runs and door openings, etc. Reinforcement with timber battens may be required in some places. Follow the foam manufacturer's instructions. To prevent indentations, the foam sheets must be protected if they are to be walked on before the floor is installed.

### **Intermediate layer**

An intermediate layer must be installed between the foam and the wood floor to avoid squeaks.

## INSTALLATION INSTRUCTIONS FOR KARELIA WOOD FLOOR ON 250 KPA EXPANDED FOAM, FLOATING, IN PUBLIC ENVIRONMENTS

---

The foam sheets must comply with at least Group T, compression strength =250 kPa (density 40 kg/m<sup>3</sup>). It is important that they are designed for this application and that they comply with the requirements for thickness tolerance and density. The density must be within ±10%.

To avoid undesirable flexing of the finished floor, the thickness tolerance of the sheets must be ±0.5 mm. For the same reason, bowed sheets must not be used.

Lay the foam sheets at right angles to the direction that the floor will be laid, and stagger them so that there are no continuous joints running lengthways along the boards. The entire subfloor must be covered with foam sheets in such a way that the boards are supported. Special attention must be given to pipe runs and door openings, etc. Reinforcement with timber battens may be required in some places. Follow the foam manufacturer's instructions. To prevent indentations, the foam sheets must be protected if they are to be walked on before the floor is installed.

## **KARELIA POLICY ON FLAWS AND REJECTION OF MATERIAL DURING INSTALLATION**

---

Should there be any doubt concerning quality, grading or visual defects, it is important that a claim must be filed prior to installing the flooring product. Installing a product will be considered as an acceptance of its delivery quality.

### **Pattern flaws**

Minor shifts in pattern, created during manufacture, are permitted between adjacent pattern boards.